



Water Technology Solution SA

Route du Verney 18
CH - 1070 Puidoux
Tél. +41 (0)32 435 15 81
Fax. +41 (0)32 435 15 82
e-mail: w-t-s@w-t-s.ch
www.w-t-s.ch

Fiche technique

**Gamme de raccords
Novo-Sit®**

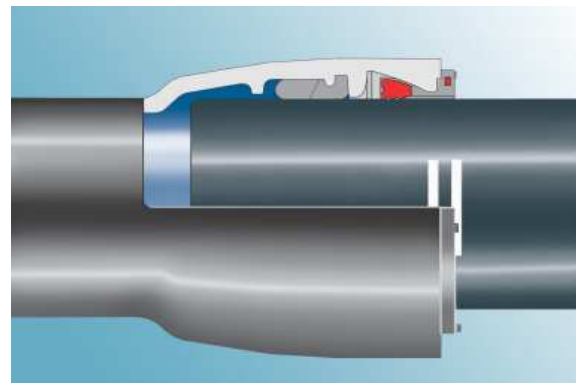
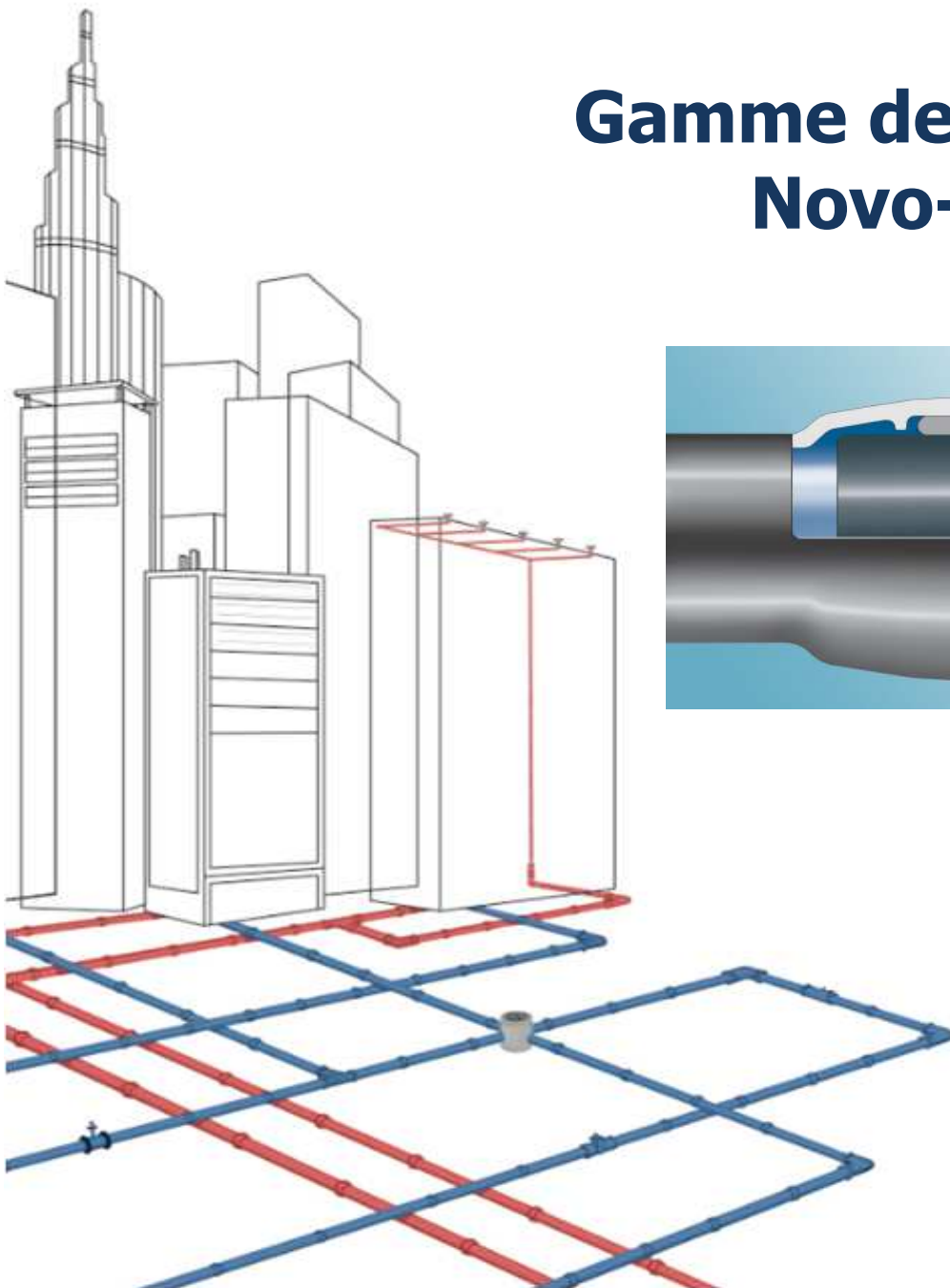





DN	Nbre de segments	PFA bar	Classe de pression	PFA bar	Classe de pression
80	5	40	C 100	25	C 50
100	5	25	C 100	16	C 50
125	7	25	C 100	16	C 50
150	10	25	C 100	16	C 50
200	13	25	C 64	16	C 50
250	18	25	C 64	16	C 50
300	22	25	C 50	16	C 50
350	22	16	C 50		
400	25	16	C 50		
450	28	16	C 40		
500	35	16	C 40		
600	45	16	C 40		
700	62	10	C 40		
800	70	10	C 40		

		DN		Art.-Nr. Epoxy
EU-Stück 	NOVO-SIT®	80		748090
	NOVO-SIT®	100		747990
	NOVO-SIT®	125		747998
	NOVO-SIT®	150		748009
	NOVO-SIT®	200		748019
	NOVO-SIT®	250		748032
	NOVO-SIT®	300		748044
	NOVO-SIT®	400		748056
	NOVO-SIT®	500		748066
	NOVO-SIT®	600		748074
	NOVO-SIT®	700		748082
	NOVO-SIT®	800		748086

		DN	Winkel		Art.-Nr. Epoxy
MK-Stück 	NOVO-SIT®	80	11°		748462
	NOVO-SIT®	100	11°		748360
	NOVO-SIT®	125	11°		748372
	NOVO-SIT®	150	11°		748382
	NOVO-SIT®	200	11°		748395
	NOVO-SIT®	250	11°		748408
	NOVO-SIT®	300	11°		748421
	NOVO-SIT®	80	22°		748465
	NOVO-SIT®	100	22°		748363
	NOVO-SIT®	125	22°		748375
	NOVO-SIT®	150	22°		748385
	NOVO-SIT®	200	22°		748399
	NOVO-SIT®	250	22°		748411
	NOVO-SIT®	300	22°		748424
	NOVO-SIT®	80	30°		748468
	NOVO-SIT®	100	30°		748366
	NOVO-SIT®	125	30°		748377
	NOVO-SIT®	150	30°		748388
	NOVO-SIT®	200	30°		748402
	NOVO-SIT®	250	30°		748414
	NOVO-SIT®	300	30°		748427

		DN ₁	DN ₂	Art.-Nr. Epoxy
MMA-Stück 	NOVO-SIT®	80	40	754554
	NOVO-SIT®	80	50	748337
	NOVO-SIT®	80	80	748341
	NOVO-SIT®	100	40	748097
	NOVO-SIT®	100	50	748100
	NOVO-SIT®	100	80	748103
	NOVO-SIT®	100	100	748094
	NOVO-SIT®	125	40	748112
	NOVO-SIT®	125	50	748115
	NOVO-SIT®	125	80	748118
	NOVO-SIT®	125	100	748106
	NOVO-SIT®	125	125	748109
	NOVO-SIT®	150	40	748131
	NOVO-SIT®	150	50	748134
	NOVO-SIT®	150	80	748137
	NOVO-SIT®	150	100	748121
	NOVO-SIT®	150	125	748124
	NOVO-SIT®	150	150	748128
	NOVO-SIT®	200	40	748155
	NOVO-SIT®	200	50	748158
	NOVO-SIT®	200	80	748161
	NOVO-SIT®	200	100	748141
	NOVO-SIT®	200	150	748145
	NOVO-SIT®	200	200	748148
	NOVO-SIT®	250	80	748181
	NOVO-SIT®	250	100	748165
	NOVO-SIT®	250	150	748170
	NOVO-SIT®	250	200	748173
	NOVO-SIT®	250	250	748176
	NOVO-SIT®	300	80	748206
	NOVO-SIT®	300	100	748184
	NOVO-SIT®	300	150	748187
	NOVO-SIT®	300	200	748190
NOVO-SIT®	300	250	748195	
NOVO-SIT®	300	300	748200	

		DN	Art.-Nr. Epoxy
EN-Stück 	NOVO-SIT®	80	747987
	NOVO-SIT®	100	747983

		DN ₁	DN ₂	Art.-Nr. Epoxy
MMA-Stück 	NOVO-SIT®	400	80	748237
	NOVO-SIT®	400	100	748209
	NOVO-SIT®	400	150	748215
	NOVO-SIT®	400	200	748218
	NOVO-SIT®	400	300	748225
	NOVO-SIT®	400	400	748231
	NOVO-SIT®	500	80	748267
	NOVO-SIT®	500	100	748241
	NOVO-SIT®	500	150	748245
	NOVO-SIT®	500	200	748248
	NOVO-SIT®	500	300	748253
	NOVO-SIT®	500	400	748258
	NOVO-SIT®	500	500	748262
	NOVO-SIT®	600	100	748270
	NOVO-SIT®	600	150	748273
	NOVO-SIT®	600	200	748277
	NOVO-SIT®	600	250	748283
	NOVO-SIT®	600	300	748288
	NOVO-SIT®	600	400	748293
	NOVO-SIT®	600	500	748296
	NOVO-SIT®	600	600	748299
	NOVO-SIT®	700	150	748303
	NOVO-SIT®	700	200	748306
	NOVO-SIT®	700	400	748311
	NOVO-SIT®	700	500	748313
NOVO-SIT®	700	600	748315	
NOVO-SIT®	700	700	748317	

		DN	Winkel	Art.-Nr. Epoxy
MK-Stück 	NOVO-SIT®	80	45°	748471
	NOVO-SIT®	100	45°	748369
	NOVO-SIT®	125	45°	748379
	NOVO-SIT®	150	45°	748391
	NOVO-SIT®	200	45°	748405
	NOVO-SIT®	250	45°	748417
	NOVO-SIT®	300	45°	748430

MMB-Stück



	DN ₁	DN ₂	Art.-Nr. Epoxy
NOVO-SIT®	80	80	748622
NOVO-SIT®	100	80	748478
NOVO-SIT®	100	100	748474
NOVO-SIT®	125	80	748489
NOVO-SIT®	125	100	748481
NOVO-SIT®	125	125	748484
NOVO-SIT®	150	80	748504
NOVO-SIT®	150	100	748492
NOVO-SIT®	150	125	748495
NOVO-SIT®	150	150	748498
NOVO-SIT®	200	80	748521
NOVO-SIT®	200	100	748507
NOVO-SIT®	200	125	748510
NOVO-SIT®	200	150	748513
NOVO-SIT®	200	200	748516
NOVO-SIT®	250	80	748538
NOVO-SIT®	250	100	748524
NOVO-SIT®	250	150	748529
NOVO-SIT®	250	200	748532
NOVO-SIT®	250	250	748535
NOVO-SIT®	300	80	748558
NOVO-SIT®	300	100	748541
NOVO-SIT®	300	150	748546
NOVO-SIT®	300	200	748549
NOVO-SIT®	300	250	748552
NOVO-SIT®	300	300	748555
NOVO-SIT®	400	100	748561
NOVO-SIT®	400	150	748564
NOVO-SIT®	400	200	748567
NOVO-SIT®	400	250	748570
NOVO-SIT®	400	300	748573
NOVO-SIT®	400	400	748576
NOVO-SIT®	500	100	748580
NOVO-SIT®	500	200	748584
NOVO-SIT®	500	300	748586
NOVO-SIT®	500	400	748588
NOVO-SIT®	500	500	748590
NOVO-SIT®	600	600	748601
NOVO-SIT®	700	250	748606
NOVO-SIT®	700	300	748608
NOVO-SIT®	700	400	748610
NOVO-SIT®	700	700	748613

		DN	Winkel	Art.-Nr. Epoxy
MMK-Stück	NOVO-SIT®	80	11°	748814
	NOVO-SIT®	100	11°	748635
	NOVO-SIT®	125	11°	748651
	NOVO-SIT®	150	11°	748667
	NOVO-SIT®	200	11°	748683
	NOVO-SIT®	250	11°	748699
	NOVO-SIT®	300	11°	748714
	NOVO-SIT®	400	11°	748735
	NOVO-SIT®	500	11°	748751
	NOVO-SIT®	600	11°	748767
	NOVO-SIT®	700	11°	748783
	NOVO-SIT®	800	11°	748799
	NOVO-SIT®	80	22°	748817
	NOVO-SIT®	100	22°	748639
	NOVO-SIT®	125	22°	748655
	NOVO-SIT®	150	22°	748671
	NOVO-SIT®	200	22°	748687
	NOVO-SIT®	250	22°	748703
	NOVO-SIT®	300	22°	748718
	NOVO-SIT®	400	22°	748739
	NOVO-SIT®	500	22°	748755
	NOVO-SIT®	600	22°	748771
	NOVO-SIT®	700	22°	748787
	NOVO-SIT®	800	22°	748802
	NOVO-SIT®	80	30°	748820
	NOVO-SIT®	100	30°	748643
	NOVO-SIT®	125	30°	748659
	NOVO-SIT®	150	30°	748675
	NOVO-SIT®	200	30°	748691
	NOVO-SIT®	250	30°	748707
	NOVO-SIT®	300	30°	748722
	NOVO-SIT®	400	30°	748743
	NOVO-SIT®	500	30°	748759
	NOVO-SIT®	600	30°	748775
	NOVO-SIT®	700	30°	748791
	NOVO-SIT®	800	30°	748806

		DN	Winkel	Art.-Nr. Epoxy
MMK-Stück 	NOVO-SIT®	80	45°	748824
	NOVO-SIT®	100	45°	748647
	NOVO-SIT®	125	45°	748663
	NOVO-SIT®	150	45°	748679
	NOVO-SIT®	200	45°	748695
	NOVO-SIT®	250	45°	748710
	NOVO-SIT®	300	45°	748726
	NOVO-SIT®	400	45°	748747
	NOVO-SIT®	500	45°	748763
	NOVO-SIT®	600	45°	748779
	NOVO-SIT®	700	45°	748795
	NOVO-SIT®	800	45°	748810

		DN	Winkel	Art.-Nr. Epoxy
MMQ-Stück 	NOVO-SIT®	80	90°	748870
	NOVO-SIT®	100	90°	748828
	NOVO-SIT®	125	90°	748832
	NOVO-SIT®	150	90°	748835
	NOVO-SIT®	200	90°	748839
	NOVO-SIT®	250	90°	748843
	NOVO-SIT®	300	90°	748846
	NOVO-SIT®	400	90°	748850
	NOVO-SIT®	500	90°	748854
	NOVO-SIT®	600	90°	748858
	NOVO-SIT®	700	90°	748862
	NOVO-SIT®	800	90°	748867

		DN ₁	DN ₂	Art.-Nr. Epoxy
MMR-Stück 	NOVO-SIT®	100	80	748874
	NOVO-SIT®	150	80	748889
	NOVO-SIT®	150	100	748883
	NOVO-SIT®	150	125	748886
	NOVO-SIT®	200	100	748892
	NOVO-SIT®	200	125	748895
	NOVO-SIT®	200	150	748898
	NOVO-SIT®	250	125	748903
	NOVO-SIT®	250	150	748906
	NOVO-SIT®	250	200	748909
	NOVO-SIT®	300	150	748913
	NOVO-SIT®	300	200	748916
	NOVO-SIT®	300	250	748919

		DN ₁	DN ₂	Art.-Nr. Epoxy
MMR-Stück 	NOVO-SIT®	400	250	748925
	NOVO-SIT®	400	300	748928
	NOVO-SIT®	500	300	748932
	NOVO-SIT®	500	400	748935
	NOVO-SIT®	600	400	748939
	NOVO-SIT®	600	500	748943
	NOVO-SIT®	700	600	748949
	NOVO-SIT®	800	600	748952

		DN	Winkel	Art.-Nr. Epoxy
MQ-Stück 	NOVO-SIT®	80	90°	748977
	NOVO-SIT®	100	90°	748956
	NOVO-SIT®	125	90°	748959
	NOVO-SIT®	150	90°	748962
	NOVO-SIT®	200	90°	748965
	NOVO-SIT®	250	90°	748968
	NOVO-SIT®	300	90°	748971

		DN	Art.-Nr.
NOVO-SIT® bestehend aus: NOVO-SIT®-Ring und TYTON®-Dichtring 		80	874590
		100	874591
		125	874593
		150	874595
		200	874597
		250	874599
		300	874601
		400	874605
		500	874609
		600	874611
	700	874613	
	800	874614	